

200mW, NPN Small Signal Transistor

FEATURES

- Low power loss, high efficiency
- Ideal for automated placement
- High surge current capability
- Moisture sensitivity level: level 1, per J-STD-020
- RoHS Compliant
- Halogen-free according to IEC 61249-2-21

APPLICATIONS

- Switching mode power supply (SMPS)
- Adapters
- Lighting application
- On-board DC/DC converter

MECHANICAL DATA

- Case: SOT-23
- Molding compound meets UL 94 V-0 flammability rating
- Terminal: Matte tin plated leads, solderable per J-STD-002
- Meet JESD 201 class 1A whisker test
- Weight: 8mg (approximately)

KEY PARAMETERS		
PARAMETER	VALUE	UNIT
V_{CBO}	30-80	V
V_{CEO}	30-65	V
V_{EBO}	5-6	V
I_C	0.1	A
h_{FE}	220-800	
Package	SOT-23	
Configuration	Single die	

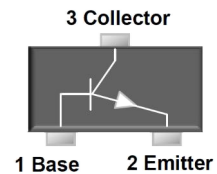

ABSOLUTE MAXIMUM RATINGS ($T_A = 25^\circ\text{C}$ unless otherwise noted)				
PARAMETER		SYMBOL	VALUE	UNIT
Marking code on the device	BC846A		1A	
	BC846B		1B	
	BC847A		1E	
	BC847B		1F	
	BC847C		1G	
	BC848A		1J	
	BC848B		1K	
	BC848C		1L	
Power dissipation		P_D	200	mW

ABSOLUTE MAXIMUM RATINGS ($T_A = 25^\circ\text{C}$ unless otherwise noted)

PARAMETER		SYMBOL	VALUE	UNIT
Collector-base voltage, emitter open	BC846	V_{CBO}	80	V
	BC847		50	
	BC848		30	
Collector-emitter voltage, base open	BC846	V_{CEO}	65	V
	BC847		45	
	BC848		30	
Emitter-base voltage, collector open	BC846	V_{EBO}	6	V
	BC847		6	
	BC848		5	
Collector current, dc		I_C	0.1	A
Junction temperature		T_J	-55 to +150	$^\circ\text{C}$
Storage temperature		T_{STG}	-55 to +150	$^\circ\text{C}$

ELECTRICAL SPECIFICATIONS ($T_A = 25^\circ\text{C}$ unless otherwise noted)

PARAMETER	CONDITIONS		SYMBOL	MIN	MAX	UNIT
Collector cutoff current	$V_{CB} = 30\text{ V}, I_E = 0$		I_{CBO}	-	100	nA
Emitter cutoff current	$V_{EB} = 5\text{ V}, I_C = 0$		I_{EBO}	-	0.1	μA
Collector-base voltage	$I_C = 10\ \mu\text{A}, I_E = 0$	BC846	V_{CBO}	80	-	V
		BC847		50	-	
		BC848		30	-	
Collector-emitter voltage	$I_C = 10\text{ mA}, I_B = 0$	BC846	V_{CEO}	65	-	V
		BC847		45	-	
		BC848		30	-	
Emitter-base voltage	$I_E = 1\ \mu\text{A}, I_C = 0$	BC846	V_{EBO}	6	-	V
		BC847		6	-	
		BC848		5	-	
DC current gain	$V_{CE} = 5\text{ V}, I_C = 2\text{ mA}$	BC846A/BC847A/BC848A	h_{FE}	110	220	
		BC846B/BC847B/BC848B		200	450	
		BC847C/BC848C		420	800	

ELECTRICAL SPECIFICATIONS ($T_A = 25^\circ\text{C}$ unless otherwise noted)					
PARAMETER	CONDITIONS	SYMBOL	MIN	MAX	UNIT
Collector-emitter saturation voltage	$I_C = 100\text{ mA}, I_B = 5\text{ mA}$	$V_{CE(sat)}$	-	0.5	V
Base-emitter saturation voltage	$I_C = 100\text{ mA}, I_B = 5\text{ mA}$	$V_{BE(sat)}$	-	1.1	V
Transition frequency	$V_{CE} = 5\text{ V}, I_C = 10\text{ mA}, f = 100\text{ MHz}$	f_T	100	-	MHz

ORDERING INFORMATION		
ORDERING CODE (Note1, 2)	PACKAGE	PACKING
BC84XX RF	SOT-23	3K / 7" Reel
BC84XX RFG	SOT-23	3K / 7" Reel
BC84XX R5	SOT-23	10K / 13" Reel
BC84XX R5G	SOT-23	10K / 13" Reel

Note:

- "xx" is device code "6A" to "8C"
- "G" means green compound (halogen free)

CHARACTERISTICS CURVES

($T_A = 25^\circ\text{C}$ unless otherwise noted)

Fig.1 Static Characteristic

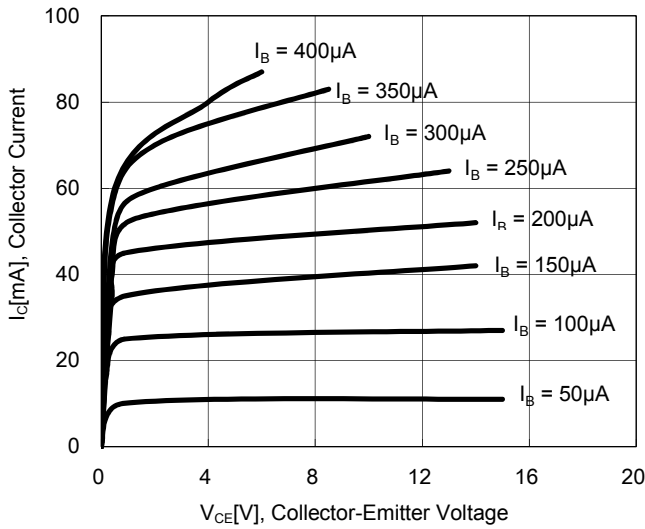
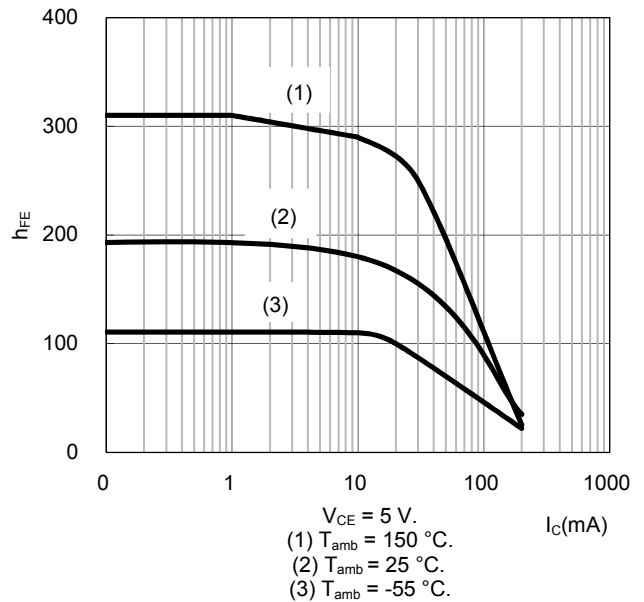

Fig. 2 DC Current Gain



**Fig.3 Base-Emitter Saturation Voltage
Collector-Emitter Saturation Voltage**

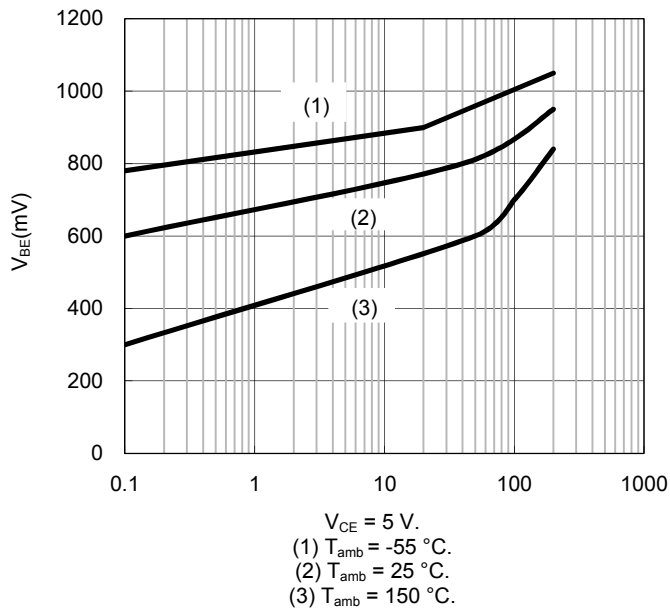
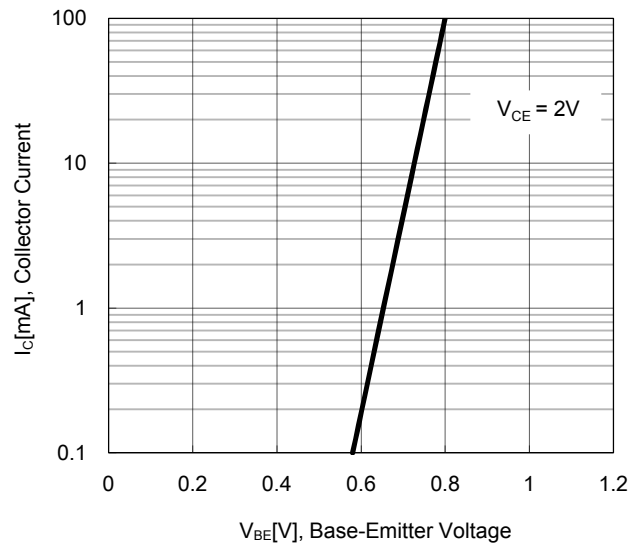

Fig.4 Base-Emitter On Voltage



CHARACTERISTICS CURVES

($T_A = 25^\circ\text{C}$ unless otherwise noted)

Fig.5 Collector Output Capacitance

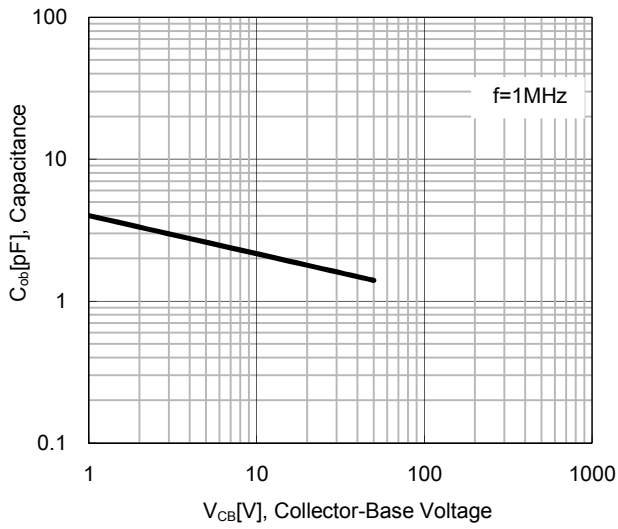
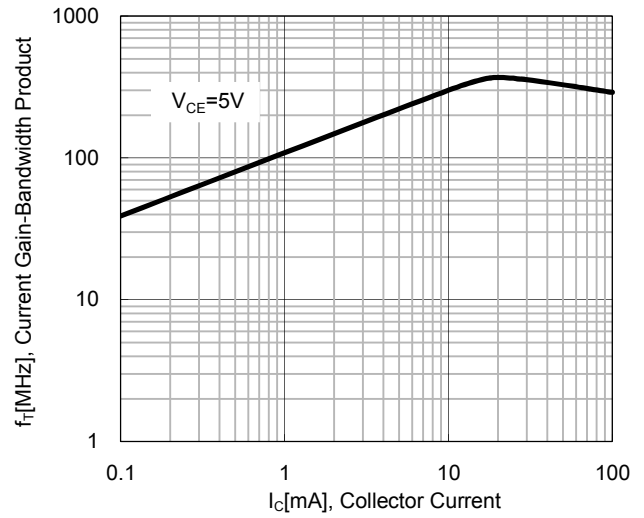
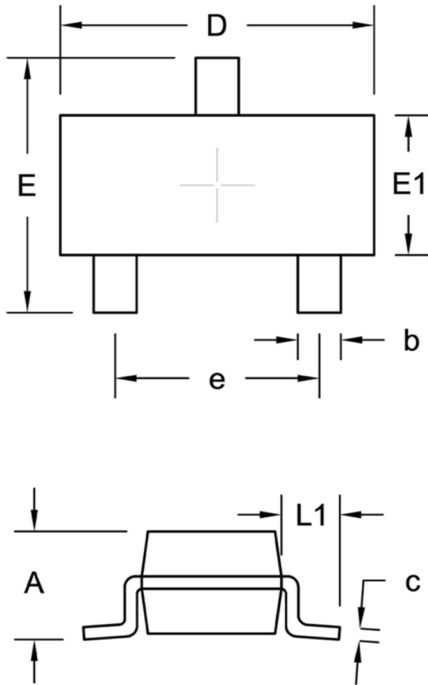

Fig. 6 Current Gain Bandwidth Product



PACKAGE OUTLINE DIMENSION

SOT-23



DIM.	Unit (mm)		Unit (inch)	
	Min.	Max.	Min.	Max.
A	0.89	1.12	0.035	0.044
b	0.30	0.50	0.012	0.020
c	0.08	0.20	0.003	0.008
D	2.80	3.04	0.110	0.120
E	2.10	2.64	0.083	0.104
E1	1.20	1.40	0.047	0.055
e	1.90 BSC		0.075 BSC	
L1	0.54 REF.		0.021 REF.	

SUGGESTED PAD LAYOUT

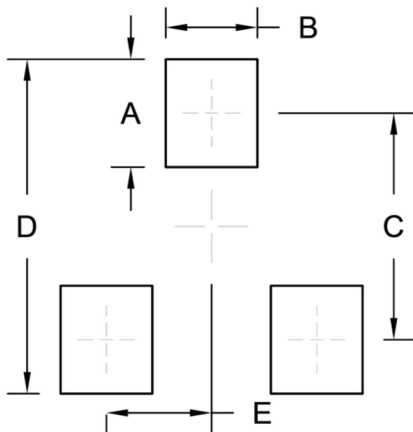

Symbol	Unit (mm)	Unit (inch)
A	1.00	0.039
B	0.85	0.033
C	2.10	0.083
D	3.10	0.122
E	0.98	0.039